

PTR08 

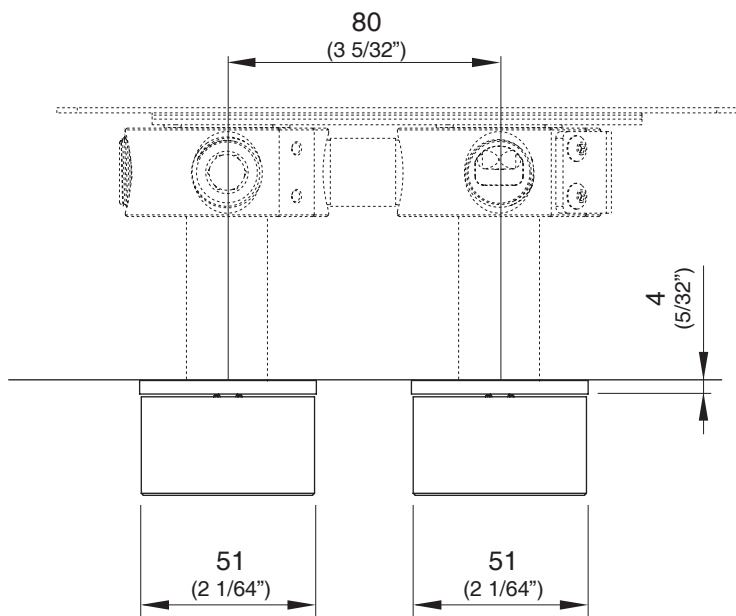

# BAR44

\_REV14

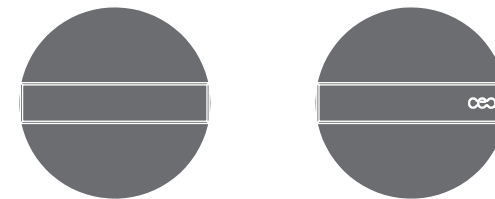

## BAR44/BAR

AISI 316/L STAINLESS STEEL

Gruppo 2 rubinetti apri/chiedi a parete con miscelazione





Wall mounted set of 2 shut-off mixing valves

DESIGN  
NATALINO MALASORTI

 Prodotto che necessita di parte incasso  
Product that needs built-in part

 Staffa ausiliaria per cartongesso / fibrogesso  
Auxiliary bracket for plasterboard / fiber-board structures

### MANUTENZIONE / MAINTENANCE

NON UTILIZZARE DO NOT USE		acido clorico e muriatico chloric and muriatic acid
		acido fluoridrico hydrofluoric acid
		ipoclorito di sodio chlorine bleach
UTILIZZARE TO USE		sapone a PH neutro neutral PH soap

Questi disegni sono proprietà di CEADDESIGN SRL s.u. pertanto non potranno essere utilizzati e/o comunicati a terzi, anche in forma parziale, senza preventiva autorizzazione. CEADDESIGN SRL s.u. si riserva il diritto di apportare modifiche ai disegni al fine di migliorare il prodotto.

CEADDESIGN SRL s.u. has the property rights on these drawings, therefore they cannot be used and/or transferred to third party, even in partial form, without any prior authorization. Furthermore CEADDESIGN SRL s.u. reserves the right to apply any change to these drawings in order to upgrade the product.

ceadesign.it

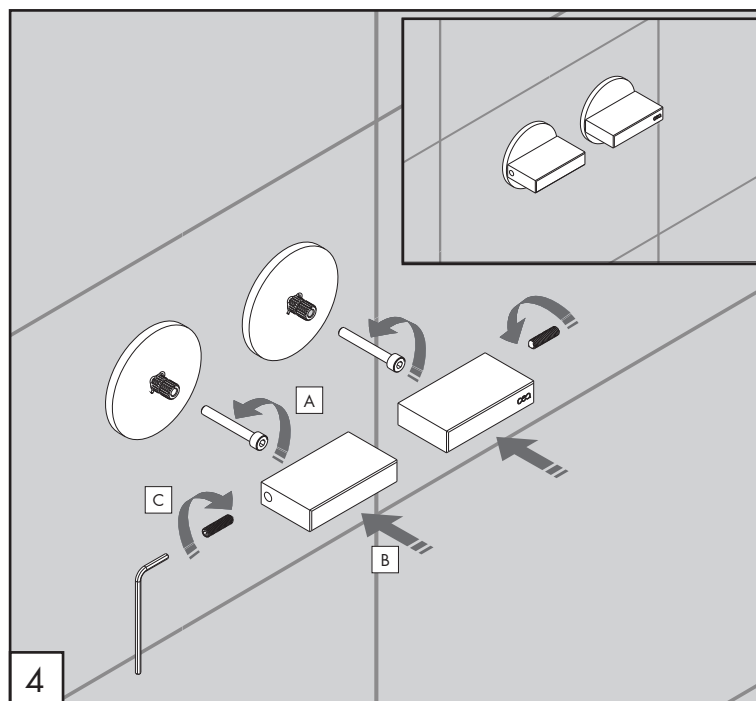
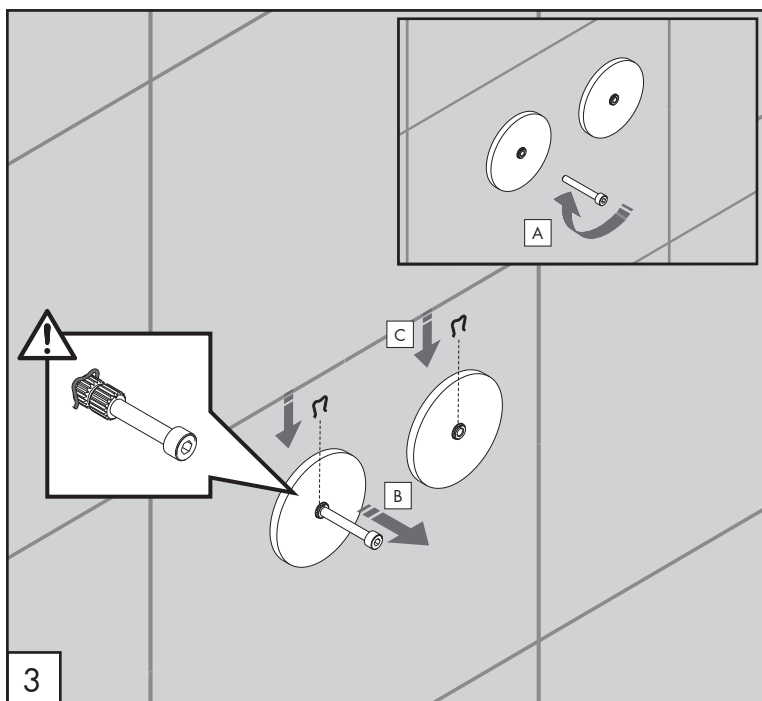
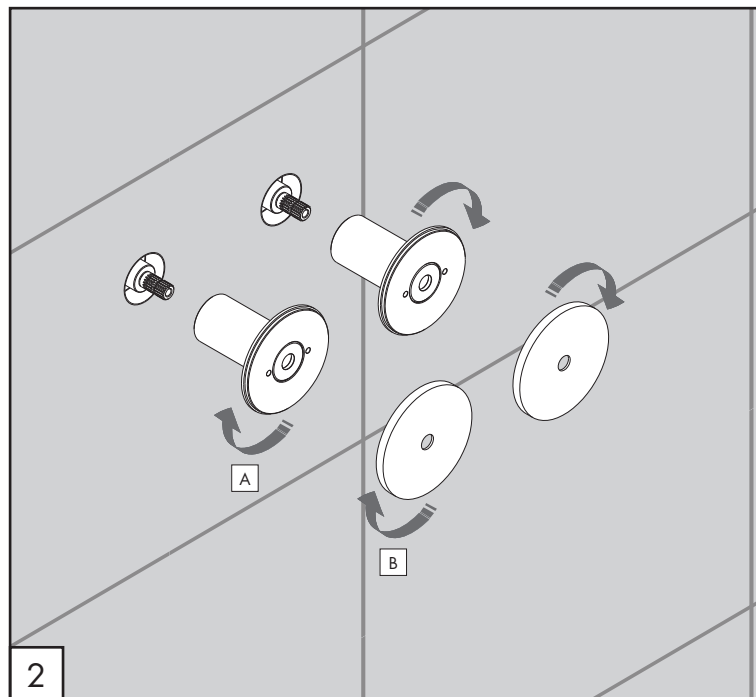
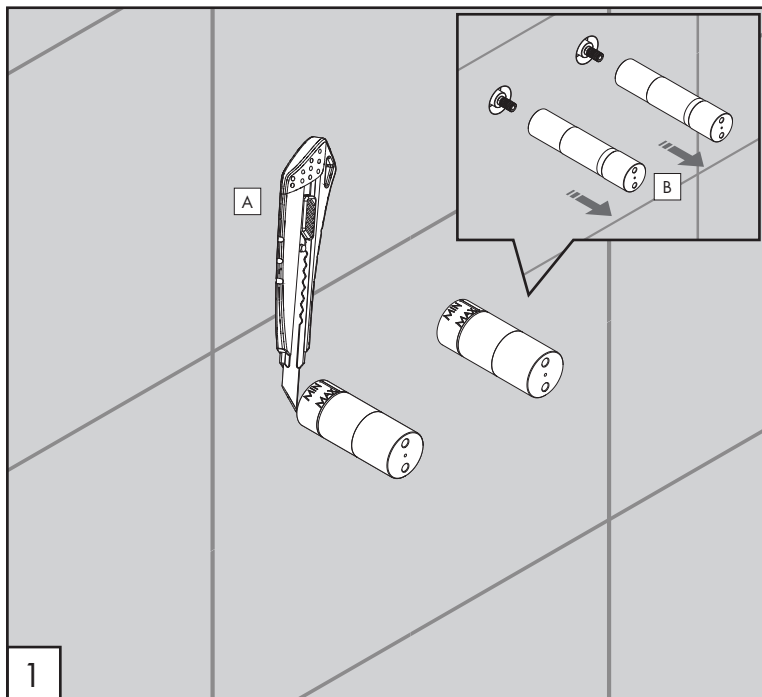

# BAR44

\_REV1.4



## AVVERTENZE TECNICHE

Risciacquare bene le tubazioni prima del montaggio ed evitare sbalzi di pressione fra i raccordi d'acqua fredda e d'acqua calda. In caso di pressioni statiche superiori a 5 bar si raccomanda l'installazione di un riduttore di pressione per evitare danni alla cartuccia.

## TECHNICAL WARNINGS

The pipes have to be rinsed thoroughly before installation. Avoid pressure differences between hot and cold water supply. Use of a pressure reducer when static pressure is higher than 5 bar to avoid damage of the cartridge.

## TECHNISCHE WARNUNG

Spülen Sie die Leitungen vor dem Einbau und verhindern Sie Wasserdruckwechsel zwischen kalt und warm Wasserverbindungen. Wenn Wasserdruck größer als 5 bar ist, bitte reduzieren Sie den Systemdruck, um Beschädigung der Kartusche zu verhindern.

## ADVERTENCIA TÉCNICA

Los tubos tienen que ser enjuagados a fondo antes de la instalación. Evitar grandes diferencias de presión entre las conexiones de agua caliente y fría. En caso de presión estática mayor de 5 bar, se recomienda el uso de un adaptador de presión para evitar daños en el cartucho.

## ADVERTISSEMENTS TECHNIQUES

Rincer les tuyaux avant l'installation. Eviter des grandes différences de pression entre l'eau froide et chaude. En cas de pressions statique de plus de 5 bar, nous vous recommandons d'installer un réducteur de pression pour éviter des dommages à la cartouche.

## PORTATE / FLOW RATE

BAR	l/min	gal/min
1	13,5	3,6
2	19,4	5,1
3*	23,8	6,3
4	27,5	7,3
5	30,6	8,1

\* Pressione consigliata  
Recommended pressure

max. 70 °C  
max. 158 °F

CEQ

COMPONENTI / PARTI DI RICAMBIO  
COMPONENTS / SPARE PARTS

RICB050	Carter / Carter
RICM117	Maniglia / Handle
RICM135	Maniglia / Handle
RICM136	Maniglia / Handle
RICR069	Rosetta / Rosette

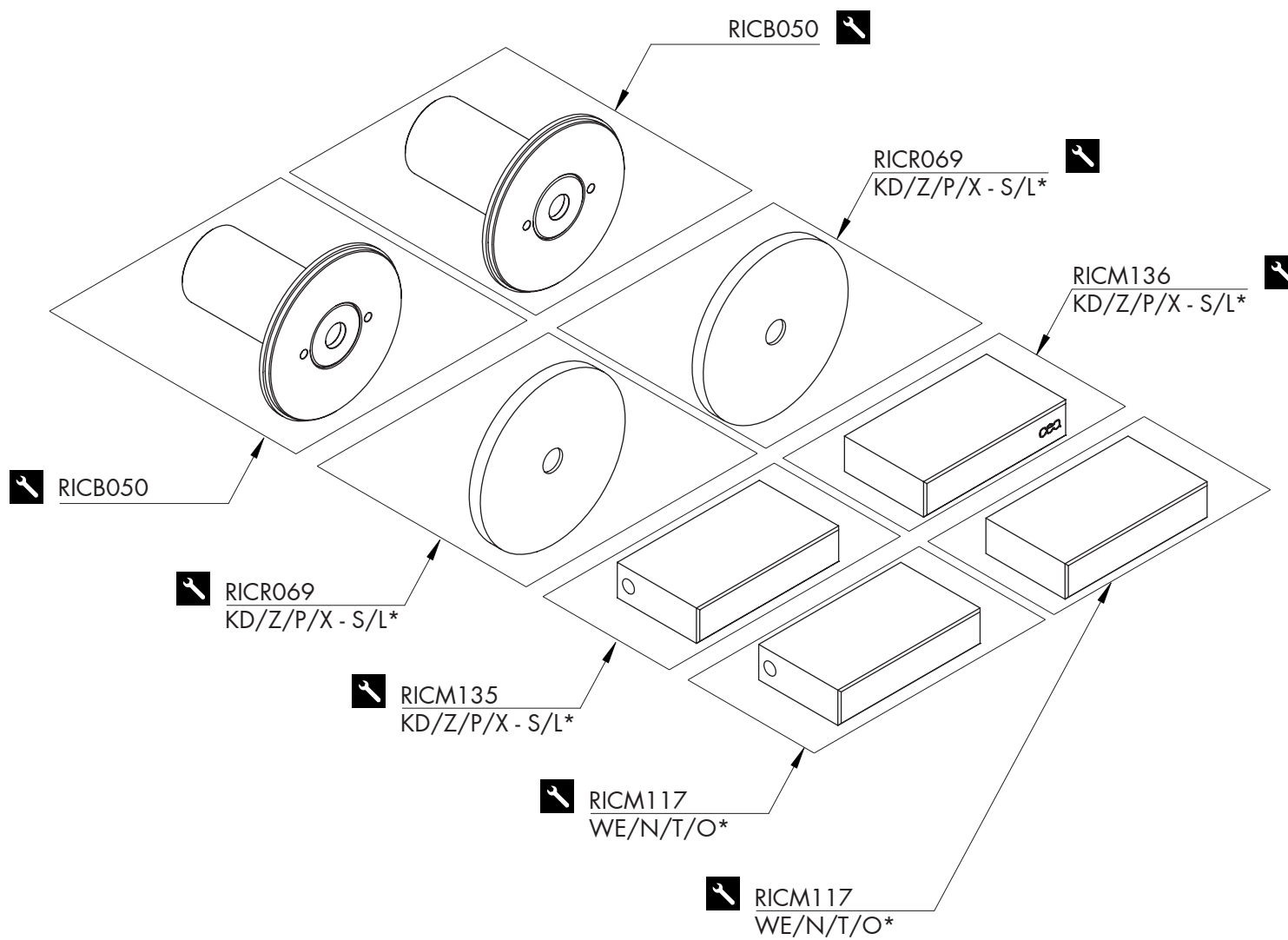

LEGENDA / LEGEND

ICONE / ICONS

 utensili inclusi nel ricambio  
tools included in spare parts

FINITURE / FINISHES

\*S finitura satinata / satin finish  
L finitura lucidata / polished finish

FINITURE SPECIALI / SPECIAL FINISHES

KD black diamond  
Z bronzo / bronze  
P rame / copper  
X light gold

ESSENZE LEGNO / WOOD ESSENCES

\*WE wengè / wenge  
N noce americano / american walnut  
T teak birmano / burma teak  
O rovere / oak