

PRODOTTI CORRELATI / RELATED PRODUCTS

FRE74 - MIL91

- +** Prodotto che necessita di parte incasso
Product that needs built-in part
- FIX** Staffa ausiliaria per cartongesso / fibrogesso
Auxiliary bracket for plasterboard / fiber-board structures

MANUTENZIONE / MAINTENANCE

NON UTILIZZARE DO NOT USE		acido clorico e muriatico <i>cloric and muriatic acid</i>
		acido fluoridrico <i>hydrofluoric acid</i>
		ipoclorito di sodio <i>chlorine bleach</i>
UTILIZZARE TO USE		sapone a PH neutro <i>neutral PH soap</i>

Questi disegni sono proprietà di CEADESIGN SRL s.u. pertanto non potranno essere utilizzati e/o comunicati a terzi, anche in forma parziale, senza preventiva autorizzazione. CEADESIGN SRL s.u. si riserva il diritto di apportare modifiche ai disegni al fine di migliorare il prodotto.

CEADESIGN SRL s.u. has the property rights on these drawings, therefore they cannot be used and/or transferred to third party, even in partial form, without any prior authorization. Furthermore CEADESIGN SRL s.u. reserves the right to apply any change to these drawings in order to upgrade the product.

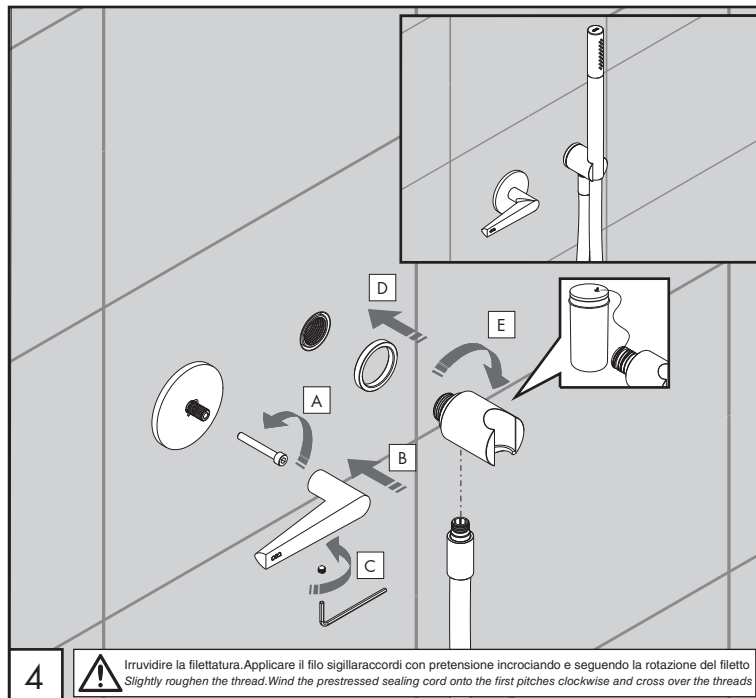
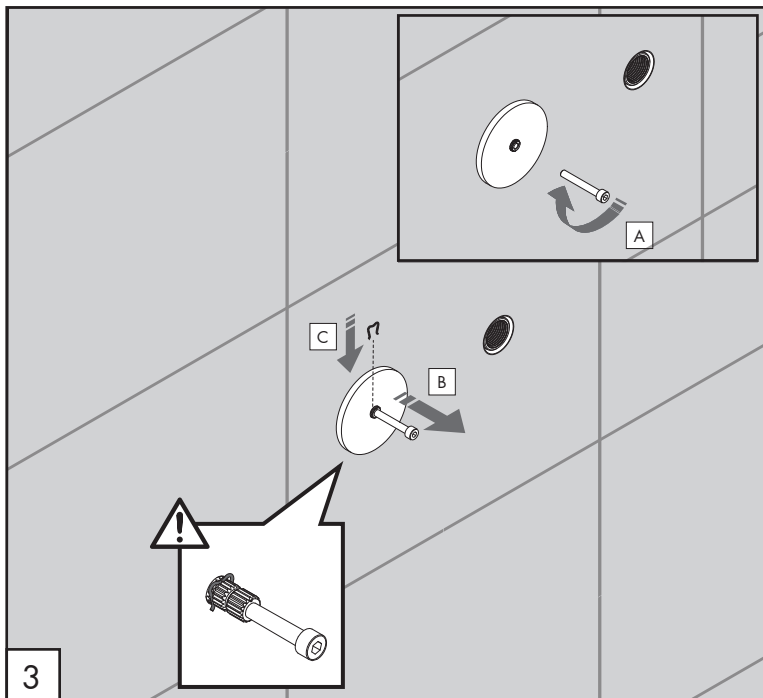
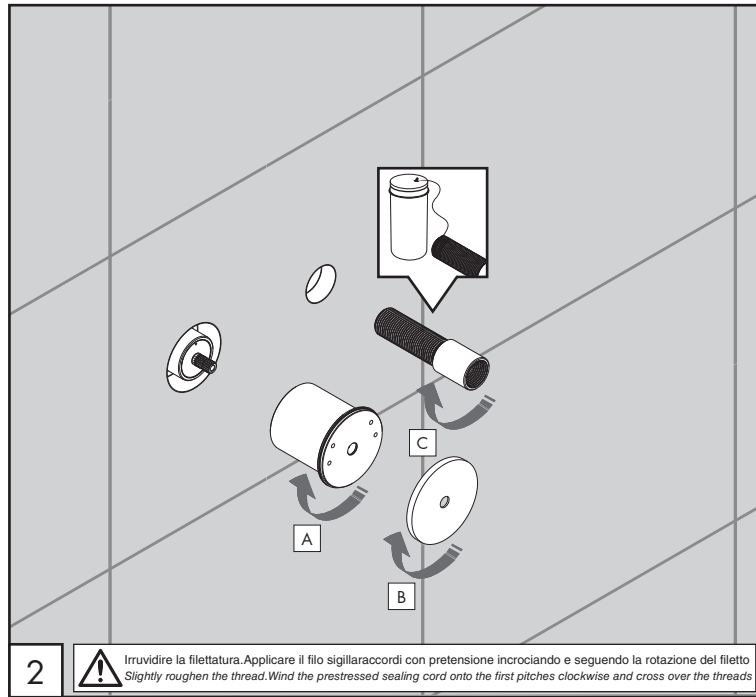
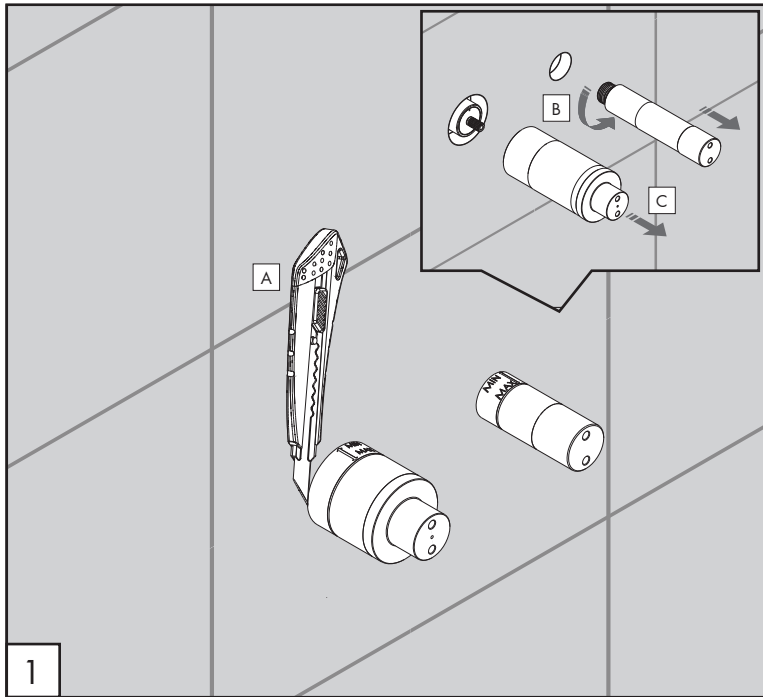

AVVERTENZE TECNICHE

Risciacquare bene le tubazioni prima del montaggio ed evitare sbalzi di pressione fra i raccordi d'acqua fredda e d'acqua calda. In caso di pressioni statiche superiori a 5 bar si raccomanda l'installazione di un riduttore di pressione per evitare danni alla cartuccia.

TECHNICAL WARNINGS

The pipes have to be rinsed thoroughly before installation. Avoid pressure differences between hot and cold water supply. Use of a pressure reducer when static pressure is higher than 5 bar to avoid damage of the cartridge.

TECHNISCHE WARNUNG

Spülen Sie die Leitungen vor dem Einbau und verhindern Sie Wasserdruckwechsel zwischen kalt und warm Wasserverbindungen. Wenn Wasserdruck größer als 5 bar ist, bitte reduzieren Sie den Systemdruck, um Beschädigung der Kartusche zu verhindern.

ADVERTENCIA TÉCNICA

Los tubos tienen que ser enjuagados a fondo antes de la instalación. Evitar grandes diferencias de presión entre las conexiones de agua caliente y fría. En caso de presión estática mayor de 5 bar, se recomienda el uso de un adaptador de presión para evitar daños en el cartucho.

ADVERTISSEMENTS TECHNIQUES

Rincer les tuyaux avant l'installation. Eviter des grandes différences de pression entre l'eau froide et chaude. En cas de pressions statique de plus de 5 bar, nous vous recommandons d'installer un réducteur de pression pour éviter des dommages à la cartouche.

TEMPERATURA DI ESERCIZIO / WORKING TEMPERATURE

max. 70 °C
 max. 158 °F

Le portate indicate sono alla pressione consigliata di 3 bar
The indicated flow rates are at the recommended pressure of 3 bar

PORTATE DOCCINO / HAND SHOWER FLOW RATE

Acciaio inox / *Stainless steel*

15,1 l/min / 4 gpm

Gomma silicónica / *Silicone rubber*

11,4 l/min / 3 gpm

RICAMBI / SPARE PARTS

RICB045	Carter / <i>Carter</i>
RICM122	Maniglia / <i>Handle</i>
RICR039	Rosetta / <i>Rosette</i>
RICR069	Rosetta / <i>Rosette</i>
RICT030	Raccordo / <i>Fitting</i>
RICU001	Supporto doccino / <i>Hand shower holder</i>

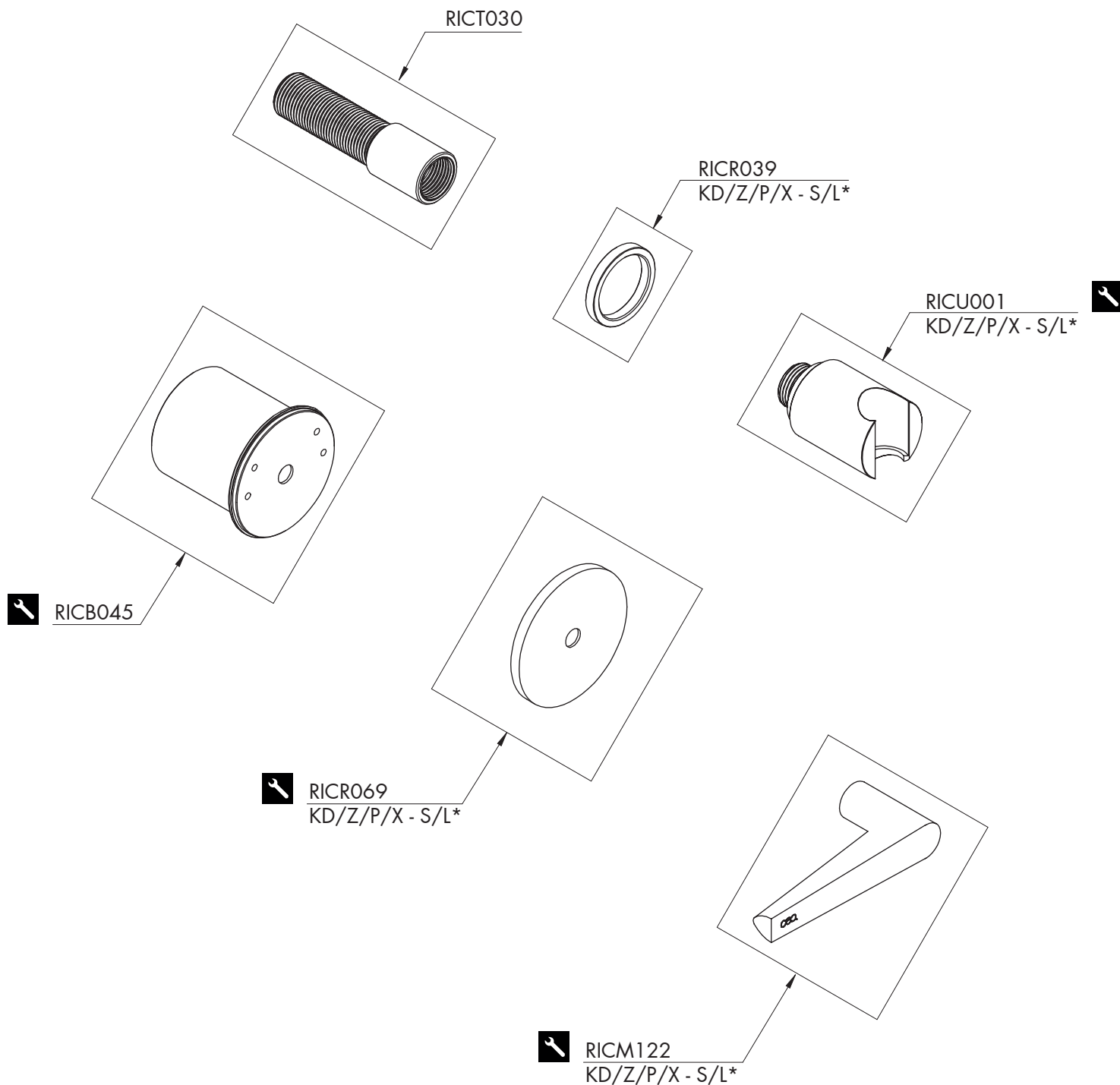

! Conservare gli strumenti inclusi nel prodotto e utilizzati per l'installazione perchè riutilizzabili per i ricambi.
Please, keep the tools included in the item pack and employed for its installation, to re-used them for the spare parts.

Die Werkzeuge, die Sie für die Installation des Produktes benutzt haben, bitte aufbewahren, da sie auch für die Installation der Ersatzteile benutzt werden können.

No tirar las herramientas incluidas en el producto y usadas durante la instalación puesto que se pueden reutilizar para los recambios.

Veillez conserver les outils inclus dans la boîte du produit et employés pour son installation, parce que réutilisables pour les pièces de rechange.

LEGENDA / LEGEND

ICONE / ICONS

Utensile incluso nel ricambio
Tool included in spare part

FINITURE / FINISHES

*S finitura satinata / *satin finish*
L finitura lucidata / *polished finish*

FINITURE SPECIALI / SPECIAL FINISHES

KD black diamond
Z bronzo / *bronze*
P rame / *copper*
X light gold

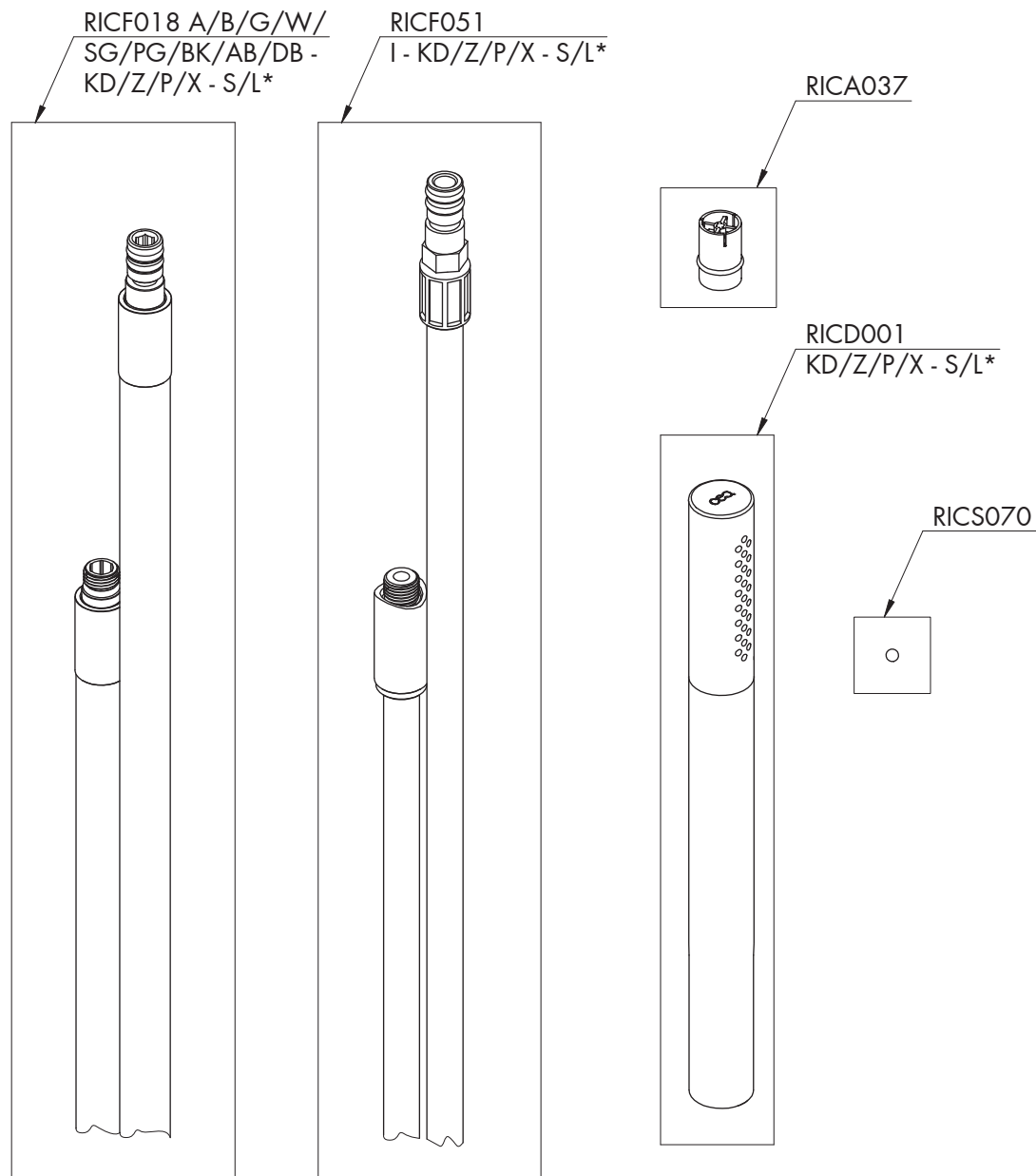

RICAMBI / SPARE PARTS

RICA037	Valvola di non ritorno / <i>Check valve</i>
RICD001	Doccino / <i>Hand shower</i>
RICF018	Flessibile / <i>Hose</i>
RICF051	Flessibile / <i>Hose</i>
RICS070	Sfera in acciaio inox Ø 3,5 mm <i>Stainless steel ball Ø 3,5 mm</i>

LEGENDA / LEGEND

ICONE / ICONS

 Utensile incluso nel ricambio
Tool included in spare part

FINITURE / FINISHES

*S finitura satinata / *satin finish*
L finitura lucidata / *polished finish*

FINITURE SPECIALI / SPECIAL FINISHES

KD black diamond
Z bronzo / *bronze*
P rame / *copper*
X light gold

COLORI FLESSIBILE / HOSE COLOURS

A	verde acqua / <i>aqua green</i>	RAL 6027
B	blu cobalto / <i>cobalt blue</i>	RAL 5013
G	grigio antracite / <i>anthracite grey</i>	RAL 7043
W	bianco / <i>white</i>	RAL 9016
SG	grigio seta / <i>silk grey</i>	RAL 7044
PG	verde petrolio / <i>petroleum green</i>	RAL 5020
BK	nero / <i>black</i>	RAL 9004
AB	blu avio / <i>air force blue</i>	RAL 5014
DB	grigio quarzo / <i>quartz grey</i>	RAL 7039
I	acciaio inox / <i>stainless steel</i>	