

2017

## BX990 L 70 x P 37 x H 25

Base portlavabo sospesa H25 - 1 CASSETTO

**TOP ESCLUSO**

Complementi: **lavabi appoggio:**  
**Boll 42** (BL42L) / **Boll 56** (BL56L) / **Monò 54** (MN54L) /  
**NudaSlim 60** (ND60L / ND60PR) / **NudaSlim 75** (ND75L /  
 ND75PR) / **Pass 39** (PS39LM) / **Pass 60** (PS60A) / **Pass 62** (PS62C)  
 / **Pass 65** (PS65AT) / **Saltodacqua** (SD42L) / **Void 44** (VD44L)  
**Specchi linea SIMPLE, MAKE-UP**

Accessori tecnici: **Sifone salvaspazio**

Dim. Imballo | Peso **12,6 kg** | Pz. Pallet n° -

CE

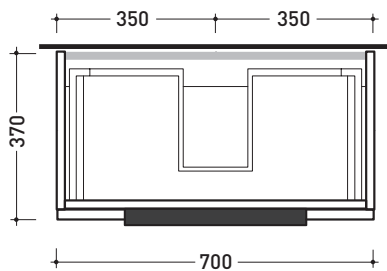

vista zenitale / zenital view

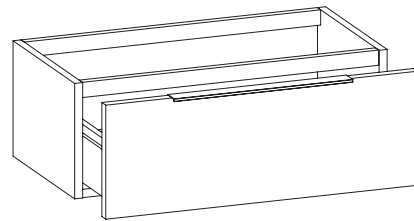

assonometria / axonometry

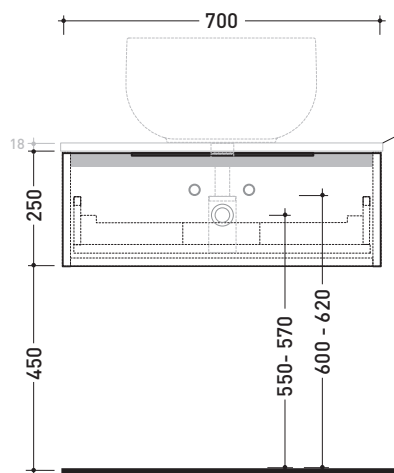

vista frontale / frontal view

TOP ESCLUSO  
TOP NOT INCLUDED

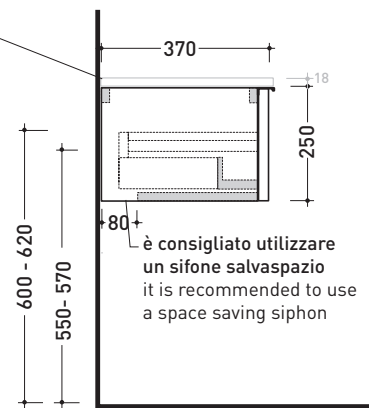

sezione longitudinale / section

è consigliato utilizzare  
un sifone salvaspazio  
it is recommended to use  
a space saving siphon

dimensioni in mm

LEGGNO: finiture



OK Arly



OJ Bianco



OJ Grigio



OJ Canapa

2017

## BX992 L 85 x P 37 x H 25

Base portlavabo sospesa H25 - 1 CASSETTO

**TOP ESCLUSO**

Complementi: **lavabi appoggio:**  
**Boll 42** (BL42L) / **Boll 56** (BL56L) / **Monò 54** (MN54L) /  
**NudaSlim 60** (ND60L / ND60PR) / **NudaSlim 75** (ND75L /  
 ND75PR) / **Pass 39** (PS39LM) / **Pass 60** (PS60A) / **Pass 62** (PS62C)  
 / **Pass 65** (PS65AT) / **Saltodacqua** (SD42L) / **Void 44** (VD44L)  
**Specchi linea SIMPLE, MAKE-UP**

Accessori tecnici: **Sifone salvaspazio**

Dim. Imballo | Peso **13,8 kg** | Pz. Pallet n° -

CE

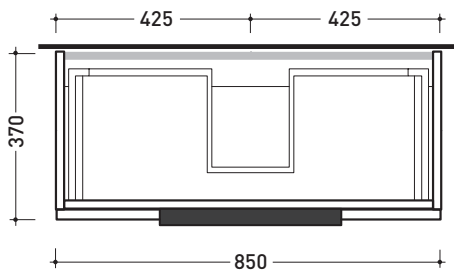

vista zenitale / zenital view

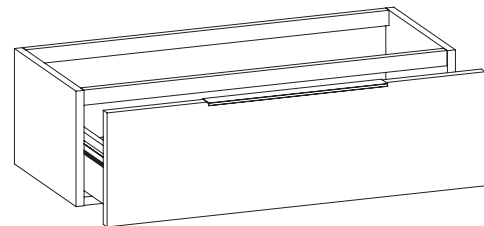

assonometria / axonometry

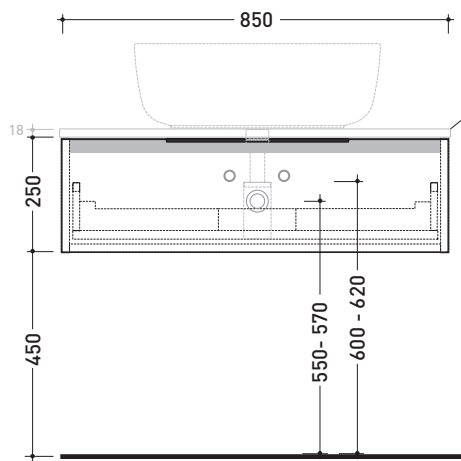

vista frontale / frontal view

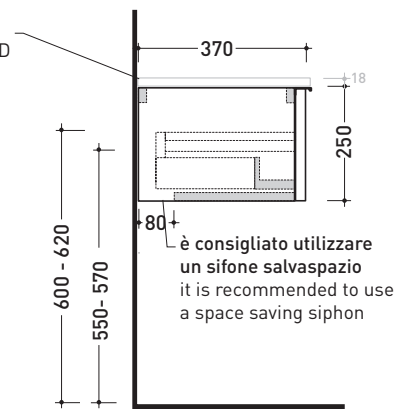

sezione longitudinale / section

dimensioni in mm

**LEGNO:** finiture



OK Arly | OJ Bianco | OJ Grigio | OJ Canapa

<http://www.ceramicaflaminia.it/it/products/342-box>

©ceramicaflaminiaspa - è vietata la copia, la pubblicazione e la riproduzione anche parziale se non autorizzata

maggio 2018



2017

## BX994 L 95 x P 37 x H 25

Base portlavabo sospesa H25 - 1 CASSETTO

**TOP ESCLUSO**

Complementi: lavabi appoggio:  
**Boll 42** (BL42L) / **Boll 56** (BL56L) / **Monò 54** (MN54L) /  
**NudaSlim 60** (ND60L / ND60PR) / **NudaSlim 75** (ND75L /  
 ND75PR) / **Pass 39** (PS39LM) / **Pass 60** (PS60A) / **Pass 62** (PS62C)  
 / **Pass 65** (PS65AT) / **Saltodacqua** (SD42L) / **Void 44** (VD44L)  
 Specchi linea SIMPLE, MAKE-UP

Accessori tecnici: **Sifone salvaspazio**

Dim. Imballo | Peso **15,1 kg** | Pz. Pallet n° -



CE

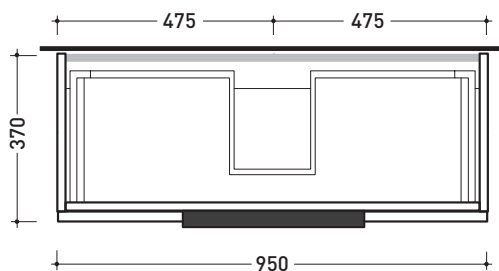

vista zenitale / zenital view

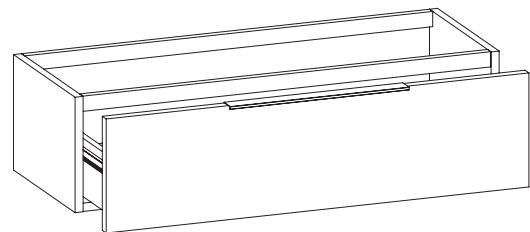

assonometria / axonometry

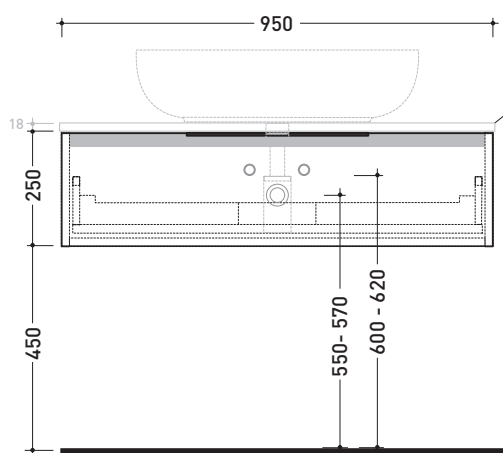

vista frontale / frontal view

TOP ESCLUSO  
TOP NOT INCLUDED

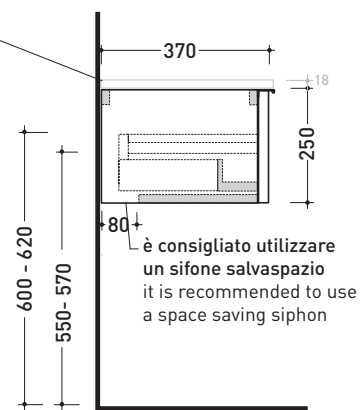

sezione longitudinale / section

dimensioni in mm

LEGNO: finiture



OK Arly



OJ Bianco



OJ Grigio



OJ Canapa

2017

## BX968 L 105 x P 37 x H 25

Base portlavabo sospesa H25 - 1 CASSETTO

**TOP ESCLUSO**

Complementi: **lavabi appoggio:**  
**Boll 42** (BL42L) / **Boll 56** (BL56L) / **Monò 54** (MN54L) /  
**NudaSlim 60** (ND60L / ND60PR) / **NudaSlim 75** (ND75L /  
 ND75PR) / **Pass 39** (PS39LM) / **Pass 60** (PS60A) / **Pass 62** (PS62C)  
 / **Pass 65** (PS65AT) / **Saltodacqua** (SD42L) / **Void 44** (VD44L)  
**Specchi linea SIMPLE, MAKE-UP**

Accessori tecnici: **Sifone salvaspazio**

Dim. Imballo | Peso **17,3 kg** | Pz. Pallet n° -

CE

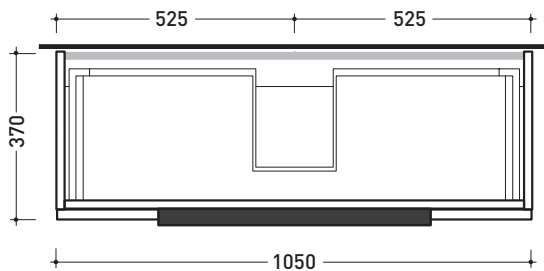

vista zenitale / zenital view

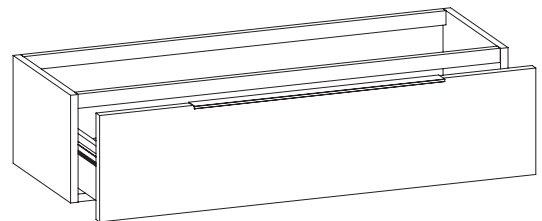

assonometria / axonometry

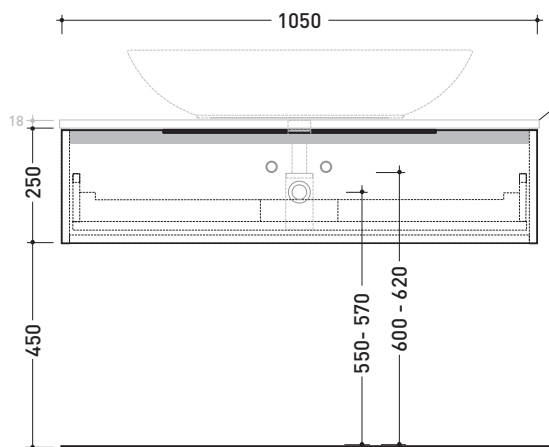

vista frontale / frontal view

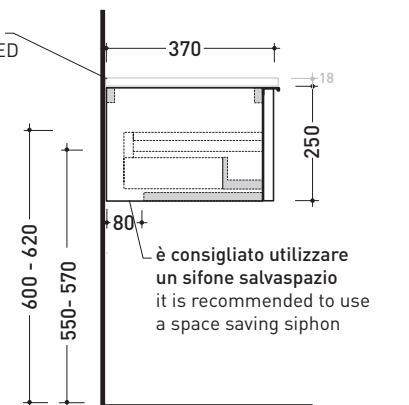

sezione longitudinale / section

dimensioni in mm

**LEGNO:** finiture



OK Arly | OJ Bianco | OJ Grigio | OJ Canapa

<http://www.ceramicaflaminia.it/it/products/342-box>

©ceramicaflaminiaspa - è vietata la copia, la pubblicazione e la riproduzione anche parziale se non autorizzata

maggio 2018



**LAVABI DA APPOGGIO COMPATIBILI**

**PROFONDITÀ BASE PORTALAVABO: CM 37**

Boll 42	art. <b>BL42L</b>
Boll 56	art. <b>BL56L</b>
Monò 54	art. <b>MN54L</b>
NudaSlim 60	art. <b>ND60L</b>
NudaSlim 60	art. <b>ND60PR</b>
NudaSlim 75	art. <b>ND75L</b>
NudaSlim 75	art. <b>ND75PR</b>
Pass 39	art. <b>PS39LM</b>
Pass 60	art. <b>PS60A</b>
Pass 65	art. <b>PS65AT</b>
Pass 62	art. <b>PS62C</b>
Saltodacqua	art. <b>SD42L</b>
Void 44	art. <b>VD44L</b>

**INDICAZIONI PER LA REALIZZAZIONE DI COMPOSIZIONI**

Fare attenzione alla differenza tra **BASI PORTALAVABO** e **BASI SOSPENSE**:

- Le **BASI PORTALAVABO** hanno il cassetto predisposto per l'alloggiamento del sifone e la parte posteriore aperta per effettuare i collegamenti idraulici.
- Le **BASI SOSPENSE** invece sono chiuse su ogni lato.

**ATTENZIONE :**

**LA POSIZIONE DEL LAVABO È SEMPRE CENTRALE RISPETTO ALLA BASE PORTALAVABO**

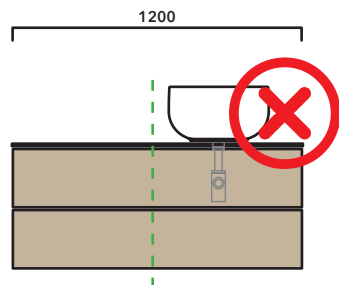
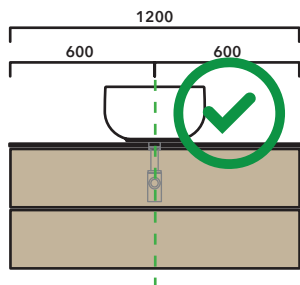

**ATTENZIONE :**

**IL TOP NON È INCLUSO**

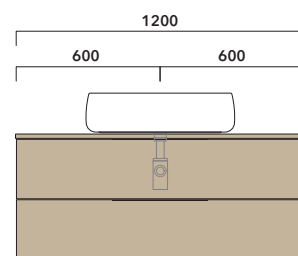
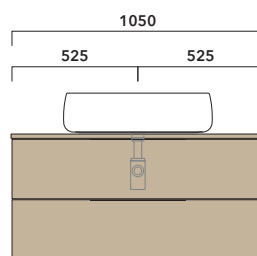
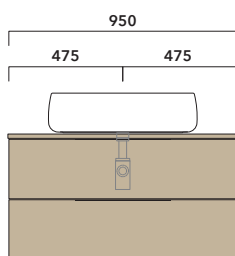
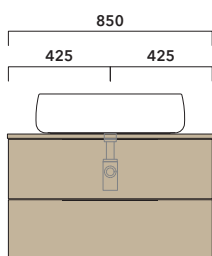
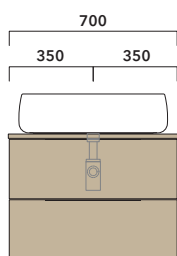

Le basi portalavabo sono utilizzabili solo con **LAVABI DA APPOGGIO** (NO incasso, semincasso, sottopiano).

## ESEMPI DI COMPOSIZIONI

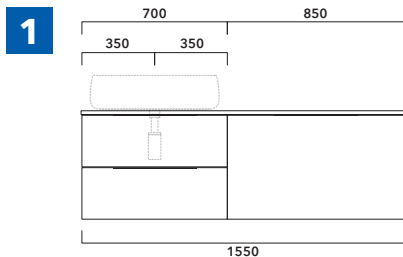

**1** | profondità cm 37:  
n.1 **BX808** + n.1 **BX426** + **BXPR38** cm 155

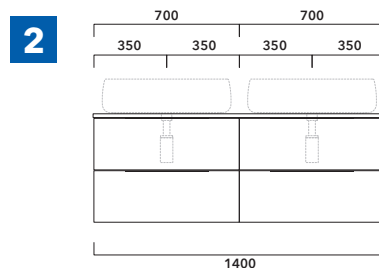

**2** | profondità cm 37:  
n.2 **BX808** + **BXPR38** cm 140

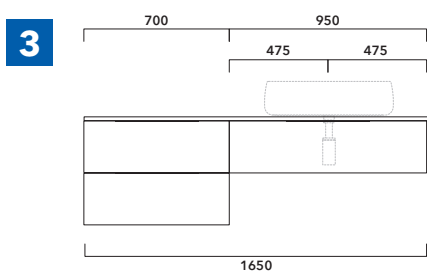

**3** | profondità cm 37:  
n.1 **BX424** + n. 1 **BX994** + **BXPR38** cm 165

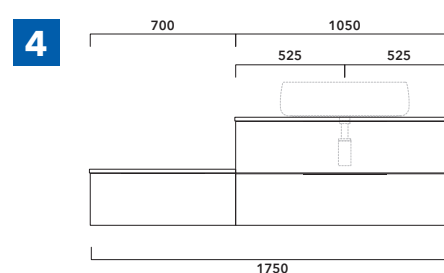

**4** | profondità cm 37:  
n.1 **BX296** + n. 1 **BX838** + **BXPR38** cm 70 +  
**BXPR38** cm 105

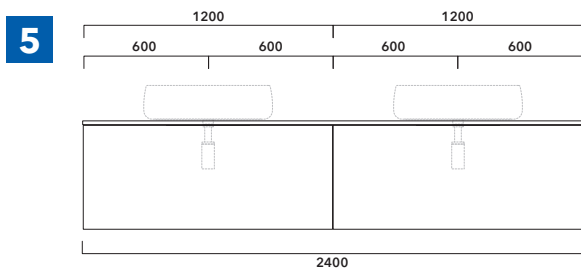

**5** | profondità cm 37:  
n.2 **BX944** + **BXPR38** cm 240

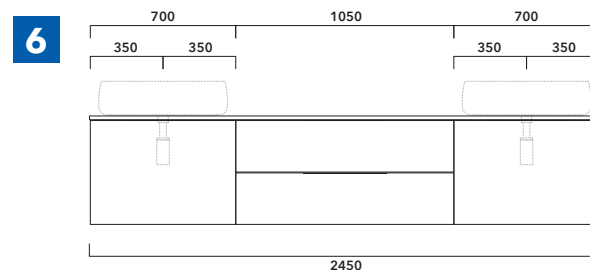

**6** | profondità cm 37:  
n.2 **BX804** + n.1 **BX436** + **BXPR38** cm 245

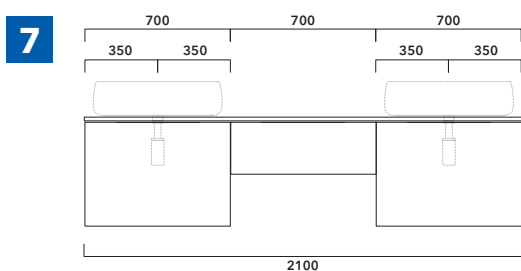

**7** | profondità cm 37:  
n.2 **BX804** + n. 1 **BX296** + **BXPR38** cm 210

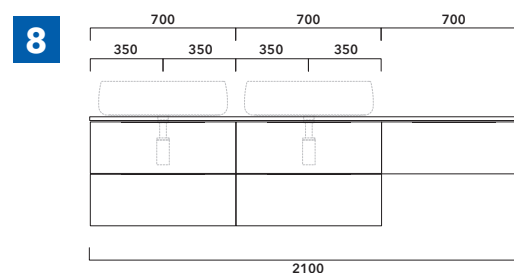

**8** | profondità cm 37:  
n.2 **BX808** + n. 1 **BX296** + **BXPR38** cm 210

➔ **FLAMINIA.** MODULO PER LA REALIZZAZIONE DELLE COMPOSIZIONI MOBILI **BOX**  
CUSTOMIZED COMPOSITION FORM FOR **BOX** UNITS



E' obbligatorio fotocopiare questa pagina, compilarla con cura e allegarla all'ordine.  
It is compulsory to photocopy this page, carefully fill in and attach to the order.

➔➔ **1** DETTAGLI ORDINE / ORDER DETAILS

ordinante - buyer \_\_\_\_\_ cliente - client \_\_\_\_\_

ordine - order n: \_\_\_\_\_ data - date: \_\_\_\_\_ ref.: \_\_\_\_\_

annotazioni - notes \_\_\_\_\_

➔➔ **2** PROFONDITÀ MOBILE / UNIT DEPTH É importante consultare il listino prezzi / It's important to consult price list

CM 37

CM 50

➔➔ **3** DISEGNO / DRAWING



➔➔ **4** ELENCO ARTICOLI / ARTICLE LIST É importante consultare il listino prezzi / It's important to consult price list

art. \_\_\_\_\_ dim. \_\_\_\_\_ art. \_\_\_\_\_ dim. \_\_\_\_\_

art. \_\_\_\_\_ dim. \_\_\_\_\_ art. \_\_\_\_\_ dim. \_\_\_\_\_

art. \_\_\_\_\_ dim. \_\_\_\_\_ art. \_\_\_\_\_ dim. \_\_\_\_\_

➔➔ **5** LAVABO DA APPOGGIO / COUTERTOP BASIN

FLAMINIA lavabo/basin art. \_\_\_\_\_

NO FLAMINIA lavabo/basin  
(allegare scheda tecnica / enclose a technical drawing)

➔➔ **6** SCELTA FINITURA / FINISH SELECTION

OK ARLY

OJ BIANCO

OJ GRIGIO

OJ CANAPA