

Quadra.1V.71x40.SF

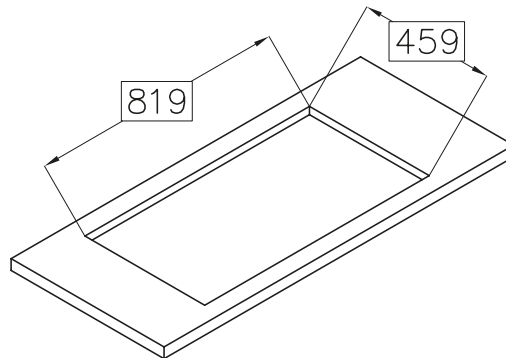

cod. 1250 050

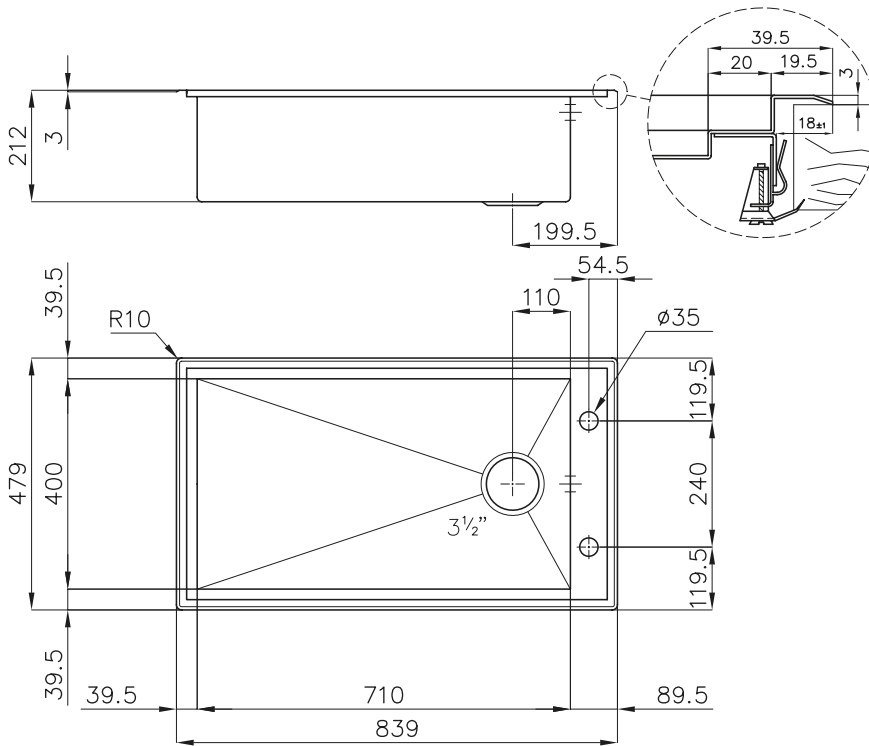

www.fosterspa.com